

FASTTOP

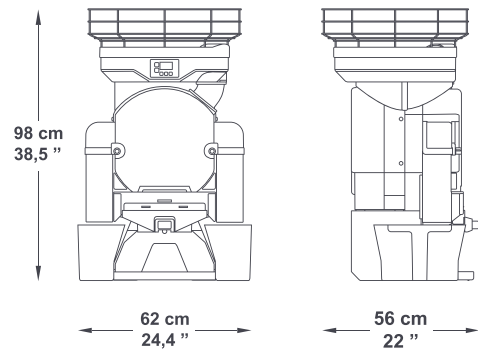

TECHNICAL FEATURES

Fruits per minute	45
Feeder capacity	25 Kg / 55 Lbs
Feeder mode	Automatic
Squeezing diameter	65-80 mm / 2,56-3,15 "
Waste bin capacity	12 Kg / 26,5 Lbs / 72 squeezed oranges approx.
Weight	51,5 Kg / 113,5 Lbs
Voltage	230 V - 50/60 Hz 115 V - 60 Hz
Energy consumption	3,7 A / 4,1 A 8,1 A
Power	550 W - 0,7 Hp
Protection	Security and locking detectors. IPx4
Recommended consumption	☹☹☹ High



OPTIONS

 **+ Self-Cleaning system**
Automatic double shower system for fast and intense cleaning of the squeezing area.

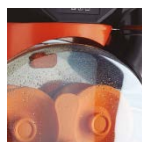

 **+ Automatic double action filter**
Transports automatically seeds and pulp into the waste bin.



 **+ Pulp-Out Filter & Stainless Steel Self-Tap**
Allows you to swipe seeds and pulp directly into the waste bin, by just sliding the Pulp-Out sweeper to the side.



 **+ ByeFly system**
The new system creates an air current in the squeezing area, keeping it free of mosquitoes and flies.

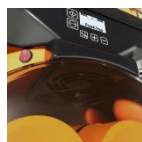

ACCESSORIES

 **+ Bottle holder**
Support for filling bottles without having to hold them.



 **+ Squeezing kit S**
45-60 mm juice squeezing kit to process small calibre fruits.



COLORS

